

CUTSHEET

Front View

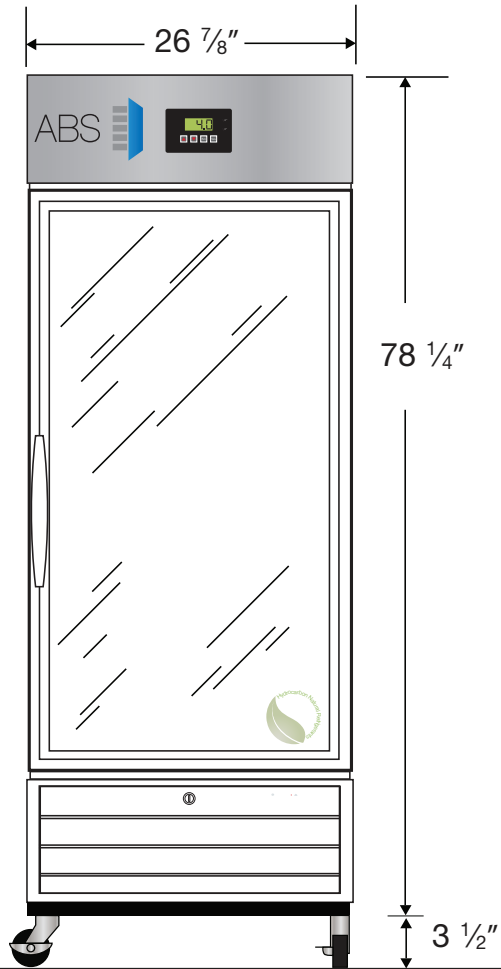

Side View

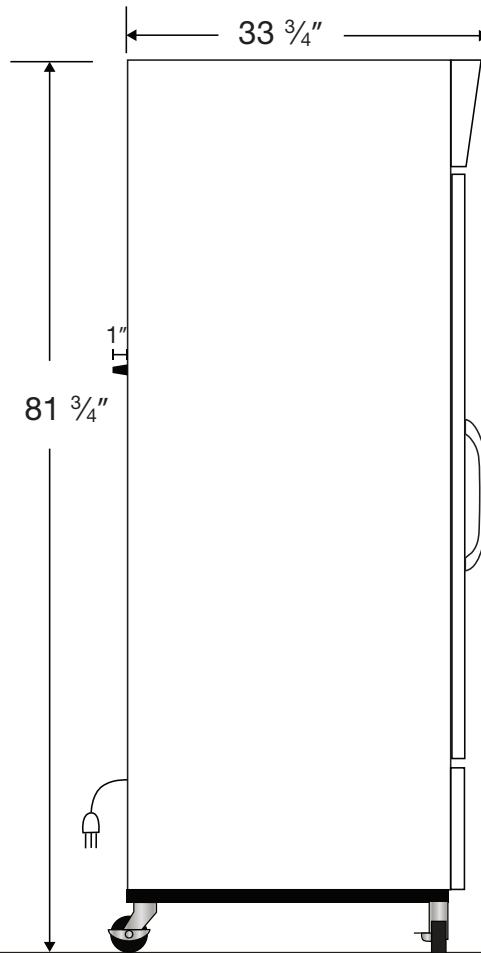

Top View

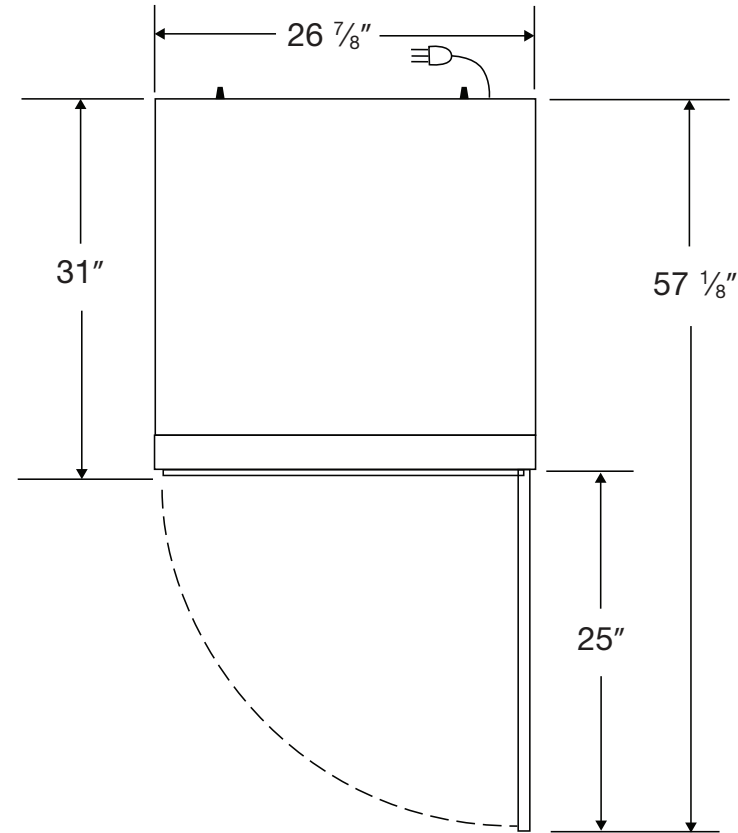

115VAC/60Hz/1PH
NEMA-5-15P

Cu. Ft	Defrost	Door	Int Door	Shelves	W"	D"	H"	Refrigerant	H.P.	Amps	Weight
23	Cycle	1 Glass	0	4 Adj.	26 7/8	34 3/4	81 3/4	R290	1/5	3	296 lbs.